



Zebra Technologies Corporation

475 Half Day Road, Suite 500

Lincolnshire, IL 60069 USA

Zebra® RW 420 Mobile Battery Eliminator Kits

Installation Instructions

RW 420 Mobile Battery Eliminator Kits

Special Notices

The following notices emphasize certain information in the guide. Each serves a special purpose and is displayed in the format shown:



Note: *Note is used to emphasize any significant information.*



Caution: *Indicates information that, if not followed, can result in damage to software, hardware, or data.*



Warning: *This warning symbol indicates an imminently hazardous situation which, if not avoided will result in death or serious injury. Before you work on any equipment, be aware of the hazards involved with electrical circuitry and be familiar with standard practices for preventing accidents*

General Warnings and Cautions



Caution: *Read the following installation instructions before you connect the system to its power source.*



Note: *Zebra Technologies Corporation is not liable for personal injury or damage to any equipment caused by the improper installation of this equipment to any power source.*

Vehicle Installation Safety



Caution: Only trained and qualified personnel should be allowed to install, replace, or service this equipment.



Caution: DO NOT USE THE PRINTER WHILE DRIVING, as this may result in property damage or personal injury. Zebra Technologies Corporation. does not promote the use of these products except when parked or stationary, and is not responsible for any loss resulting from the use or misuse of our products.





Caution: Do not install the battery eliminator kit where it will be exposed to precipitation, extreme temperatures or excessive condensation.



Caution: Do not install the battery eliminator kit in a location that will affect vehicle safety or drivability.

 Caution: Never install or remove the equipment from the vehicle's electrical system while the vehicle is running. This may result in permanent damage to the equipment.

 Warning: It is very important to ensure that you make the correct cable to power source connections, because electrical energy from a vehicle's power system can harm equipment and people.

 Ensure that the Power Supply has proper cooling. Do not place any padding or cushioning material under the unit or next to the back of the unit.

Electrical Information

Power Supply Input: 11VDC to 16VDC

 Caution: Since the RW 420 Mobile Battery Eliminator consumes vehicle power even when the printer is turned off, it **MUST** be connected to a power source that is switched off when the vehicle is turned off.

Zebra Technologies Corporation is not liable for damage to any equipment caused by improper installation of this equipment to any power source.

Regulatory Information

Regulatory Markings

Type-approval labels indicate compliance with country regulations. This product carries country-specific labels to indicate compliance.

Radio Frequency Interference Regulations

This device complies with Part 15 of the FCC Rules. Operation is subject to the following two conditions: (1) This device may not cause harmful interference and (2) this device must accept any interference received including interference that may cause undesired operation.

RW 420 Mobile Battery Eliminator Kits

Notification of Canadian Requirements

This Class B digital apparatus complies with Canadian ICES-003.
Cet appareil numérique de la classe B est conforme à la norme NMB-003 du Canada.

Product Safety Regulatory Marking

Regulatory labels indicate compliance with safety standards. This product carries one or more of the following labels: UL, CE, TUV and/or CS.

Introduction



NOTE: Zebra Technologies Corporation is not liable for personal injury or damage to any equipment caused by the improper installation of this equipment to any power source.

The RW 420 Mobile Battery Eliminator Kits consist of the following:

- The DC to DC Vehicle Plug (Zebra p/n P1003766-001) for the cigarette lighter plug version **OR** the DC to DC Open Terminal (p/n P1003766-002) for direct wiring to the vehicle electrical system version
- The DC Transfer Pack Assembly (Zebra p/n P1000721)



NOTE: When ordering the Mobile Battery Eliminator Kit, specify either the cigarette lighter version or the direct wiring version to go along with the DC Transfer Pack Assembly, not both.



Caution: All of these systems must be connected in strict accordance with the instructions in this document. Failure to install this equipment per these instructions will void the warranty.

Installing the DC Transfer Pack

The following instructions detail the installation for the components listed above, which will allow a RW 420 printer to run from a DC power source.

- Turn off the printer and remove the battery pack.
- Plug the DC Transfer Pack assembly into the printer. The battery pack assembly resembles and installs like a normal battery.

FIGURE 1: DC TRANSFER PACK INSTALLATION

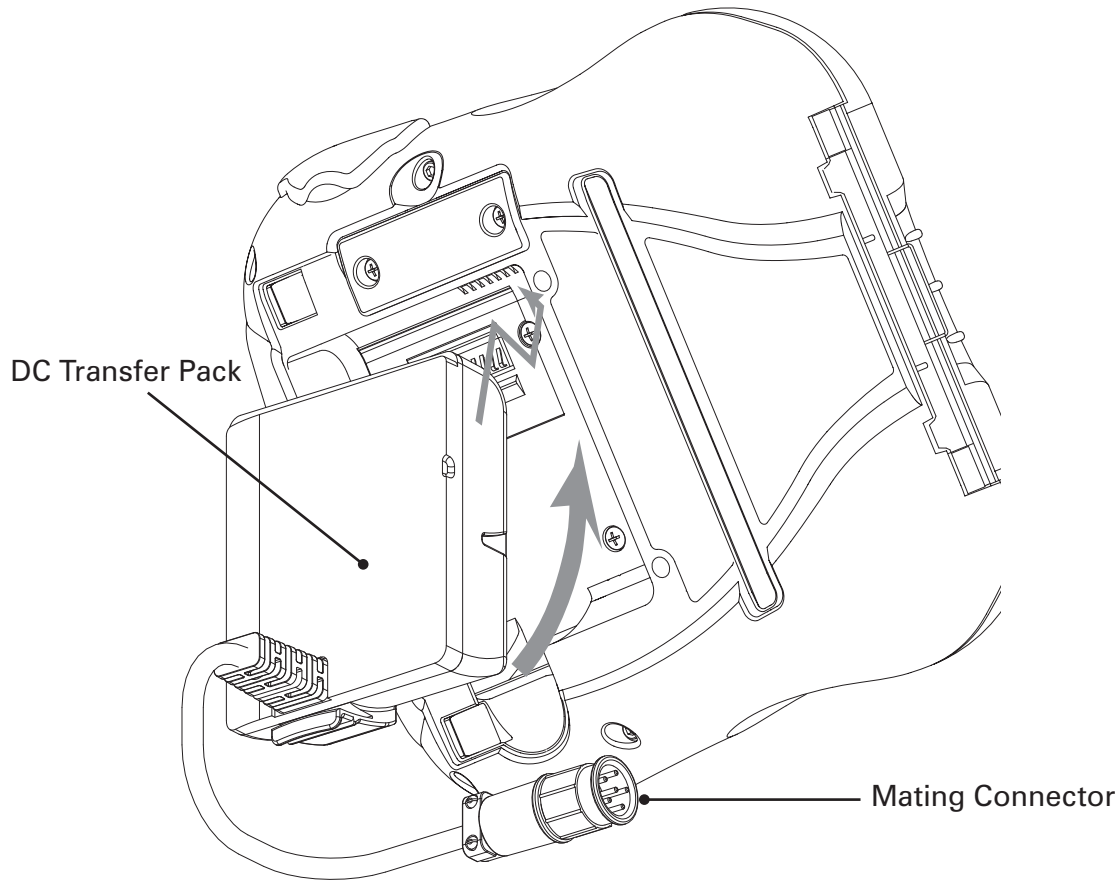

- Plug the DC cable from the Power Supply into the mating connector from the DC Transfer Pack. The plugs are polarized to ensure correct installation. They can only be connected one way. Do not attempt to force a connection. Secure the connection by turning the locking ring on the DC cable connector until it clicks into place.



Caution: Since the RW 420 Mobile Battery Eliminator consumes vehicle power even when the printer is turned off, it **MUST** be connected to a power source that is switched off when the vehicle is turned off. Zebra Technologies Corporation is not liable for damage to any equipment caused by improper installation of this equipment to any power source.



Note: When the vehicle's power is turned on, the printer's LCD will indicate the battery is full at all times.

- If installing the cigarette lighter version, fully seat the cigarette lighter into the vehicle cigarette receptacle. **IMPORTANT:** Ensure that the cigarette lighter receptacle is rated for at least 15ADC. **DO NOT** use an accessory receptacle intended for low current accessories.
- If installing the permanent bare-wire installation version, follow good wiring practices and connect to a fused connection point on the vehicle electrical fuse block.

FIGURE 2: POWER SUPPLY VEHICLE CONNECTORS

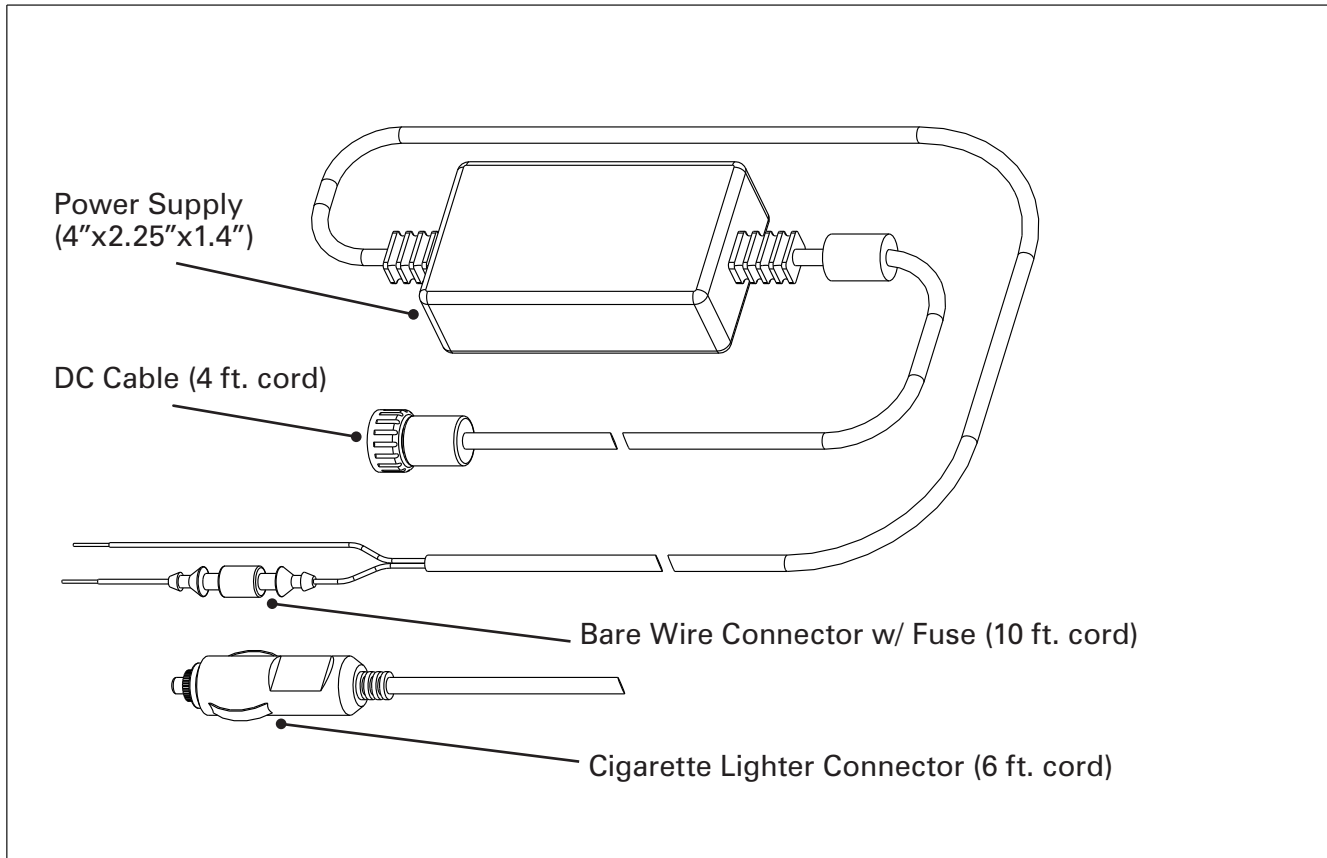

A green LED will light on the power supply to indicate the power is on. An amber LED will light to indicate an error condition is present. If the error condition occurs, unplug the printer from the power supply and turn off the vehicle power. Reconnect the printer to the power supply, and if the amber LED remains on, contact technical support.

- Turn on the printer. Load the printer with media and press the feed button to ensure that the printer is properly connected and the media has been properly installed. The printer will be able to print as long as the vehicle power stays on.

The power supply can be located on any convenient surface within 6 ft. (1.83m) of the printer. Locate the power supply where it will receive adequate ventilation. Do not locate it near the operator's feet or where it could hinder operation of the system or vehicle controls. Ensure that the cable routing does not invite damage to either the charger or the printer.

When attaching the RW420 to the RAM mount and the RAM mounting plate using the RAM Mount Kit (Zebra p/n P1011898), be sure to properly route the DC Transfer Pack connector and secure the printer to the mounting plate.

FIGURE 3: RAM MOUNT CABLE ROUTING

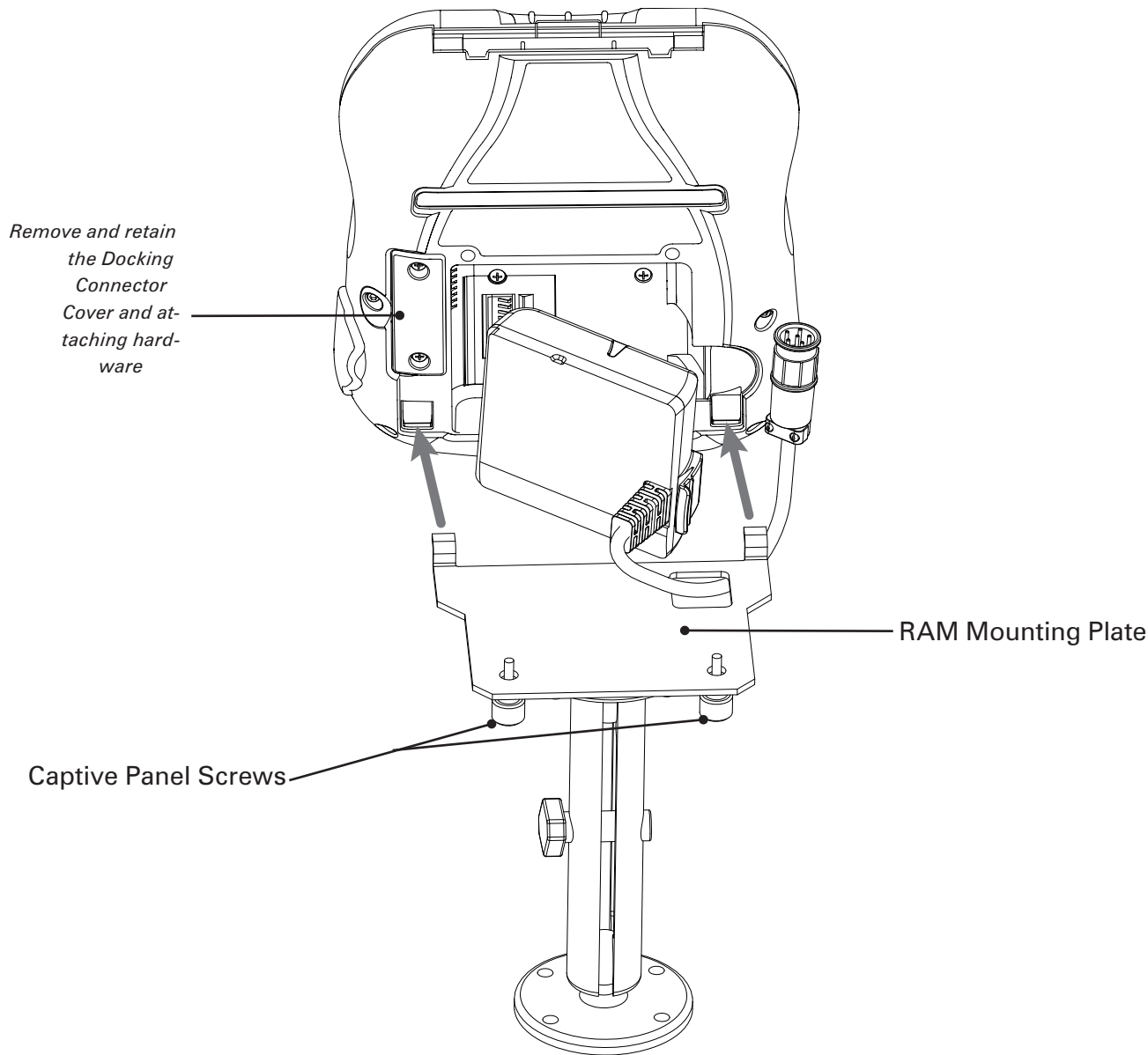

- Feed the DC Transfer Pack cable connector through the opening in the RAM Mounting Plate as shown in Figure 3.
- Insert the two raised clips on the mounting plate into the corresponding openings on the bottom of the printer as indicated.
- Rotate the printer onto the mounting plate and secure with two #6 captive panel screws.

Technical Support

U.S. Only

Zebra maintains a help line for questions involving installation of the RW 420 Mobile Battery Eliminator Kit. Please have as much information as possible regarding your particular application ready when you call to enable the technical support person to properly help you. The number in the U.S. is (800)-423-0442 and is open Monday through Friday from 8:00 am to 4:30 pm EST. Ask for Mobile Printer Technical Support.

All Others

For technical support please contact your local Zebra sales representative.



Zebra Technologies Corporation

475 Half Day Road, Suite 500
Lincolnshire, IL 60069 USA
T: +1 847.634.6700 or +1 800.423.0442



**Printed on
chlorine-free
recycled paper.**